

Roll-out Floor Isolation System

Model RIM (Roll-out Isolation Material) System

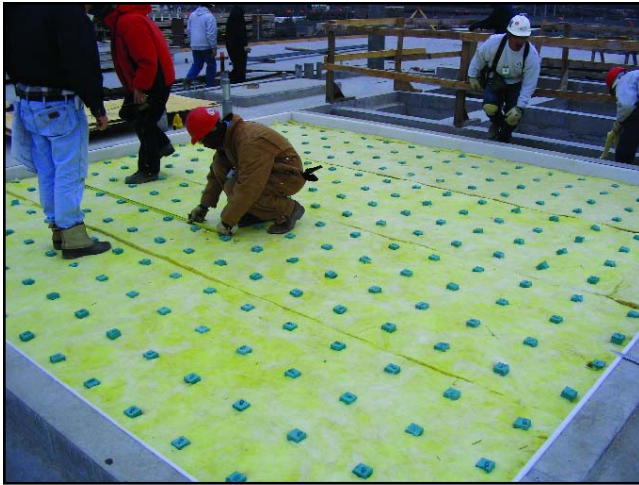

Floor Isolation Theory:

Floor isolation systems are incorporated into building design to minimize floor impact noise and airborne sound transmissions. A “floated” floor (or rooftop) is supported by resilient mounts installed on the structural floor or rooftop. The design of an effective isolation system is dependent on several factors including:

- 1.) Stiffness and mass of the structural floor,
- 2.) Isolation mount natural frequency and damping characteristics,
- 3.) Airspace height and venting,
- 4.) Mass and composition of the floated floor,
- 5.) Sound absorption in the airspace
- 6.) Control of sound flanking paths.

Creating airspace between the structural and isolated floors while decoupling the two floors with the appropriate resilient mount effectively controls noise transmission. Maximum effectiveness of floating floor composite construction is achieved when the finished floor is fully isolated from the building structure and

non-structural components, such as ductwork and piping. Accordingly, airborne and impact noise transmissions are greatly reduced between the room incorporating the floating floor system and other parts of the building. Additionally, floating floor systems are often used to prevent transmission of vibration and airborne noise from entering into the space in which the floating floor is installed. One such application would be the construction of floating floors for a multiplex theater adjacent to a railway. Kinetics Noise Control floating floor systems offers the largest variety of isolation mounts to fit specific applications. These include resilient pre-compressed fiberglass pads, steel springs, and neoprene or natural rubber pads. Acoustical test data for Sound Transmission Class (STC) and Impact Insulation Class (IIC) are available for several types of isolated floor/ceiling assemblies documenting system performance.

Application:

Kinetics Noise Control's premier rollout system easily creates an airspace of 1 to 4 inches and incorporates a high-performance resilient decoupler. The isolation material with Model KIP isolators selected and spaced according to design criteria offers major advantages over other systems. Installation labor is substantially reduced, as it is easier to roll out batting with pre-spaced isolators versus measuring for and placing individual isolation mounts. This feature also ensures that the system will reach the high levels of expected performance. This system is designed to meet requirements for; load capacity, natural frequency/pad deflection, and acoustical performance.



Installation Sequence:



1) Place Perimeter Board (Model PIB)



2) Roll-out Model RIM and cut as needed



3) Secure junction plates on plywood pouring form



4) Cover with poly layer. Ready to install reinforcement and pour concrete.

Concrete Floated Floor:

Benefits:

- STC 73/IIC 70 Tests A2-b and A3
- Greater load capacity at a lower cost
- Can be designed for any load range
- Easy to create 1", 2", 3", and 4" airspaces
- Fast, simple, inexpensive installation
- Factory installation and supervision available
- Model RIM System successfully installed for over 45 years
- Natural Frequency constant over a wide load range

Successfully installed for years under concrete floors found in mechanical rooms, studios, ballrooms, and theaters, Kinetics Noise Control's Model RIM System remains the leading formwork technique for isolating concrete slabs in any floor or roof system requiring sound abatement. An original, Model RIM System consistently provides continuous, high-performing noise control for critical applications. Our pour-in-place floor isolation system incorporates all critical components needed in a top-performing noise control system including: Model KIP isolators fixed in fiberglass batting, Model PIB Perimeter Isolation Board, spray adhesive, plywood junction plates, polyethylene sheeting and tape, and resilient, non-hardening perimeter sealant. Model KIP isolators spaced 12-, 16-, or 24-inches on center are available in different densities allowing for a multitude of load ranges under a single slab while maintaining a constant natural frequency. Factory-trained sales representatives can help designers determine which system to use based on dead and live load requirements. Kinetics Engineering Group will provide design submittals. The fiberglass batt with Model KIP isolators pre-spaced is rolled-up and delivered in poly bags along with the specified accessories to the jobsite.

Installation of Model RIM is quick and easy. Decouple the area being treated by installing Perimeter Isolation Board (Model PIB) around the perimeter of the room. Additionally, Model PIB is used as a resilient break against any other non-isolated elements such as curbs, drains, ductwork, adjacent floors, pipe, and walls. The fiberglass batt with pre-spaced isolation pads is then rolled out over the structural floor. A pouring form is created by placing plywood on top of the isolators, and is held together using junction plates and screws. Two layers of 6-mil poly overlapped and taped at the seams cover the pouring form as temporary waterproofing. Concrete reinforcement is installed and then concrete poured in place. As dictated by the designer, trades can move about the floor to complete work in the space without the concrete having been cured to full strength – the floor is already positioned at final design elevation. There is no worry about keeping the floor clear for a second visit to "lift" the slab by an installation crew. The final installation step of the Model RIM System requires removing the Model PIB tear strip and sealing the perimeter of the floating floor with resilient, non-hardening caulk.

**McAinch Art Center
College of DuPage Studios**

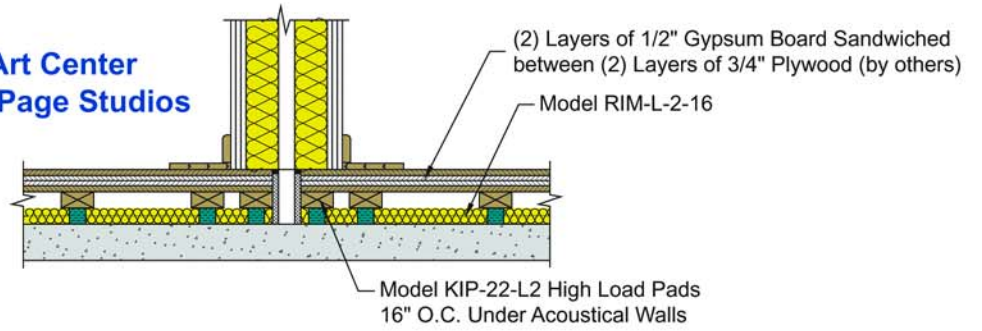

Neonopolis Multiplex Theater

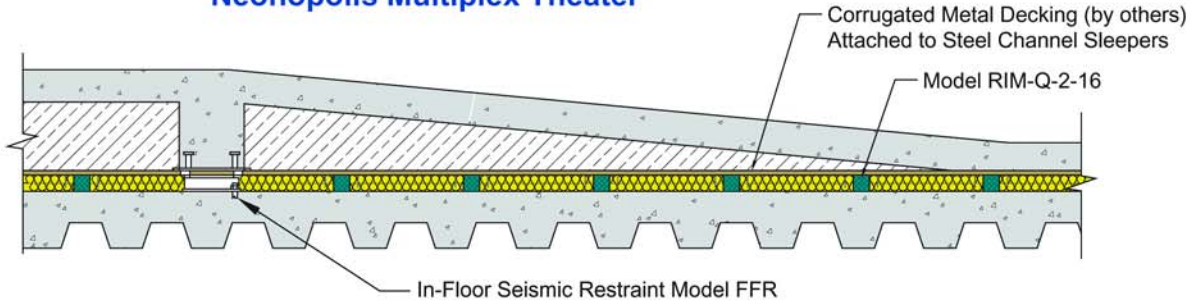

**Boston University Arena
Mechanical Room**

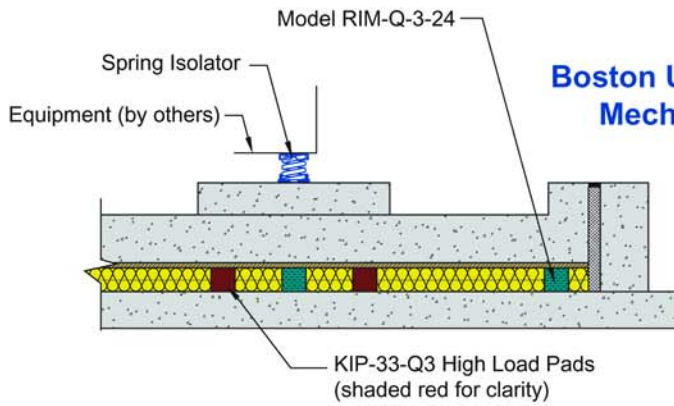

Children's Learning Center Auditorium

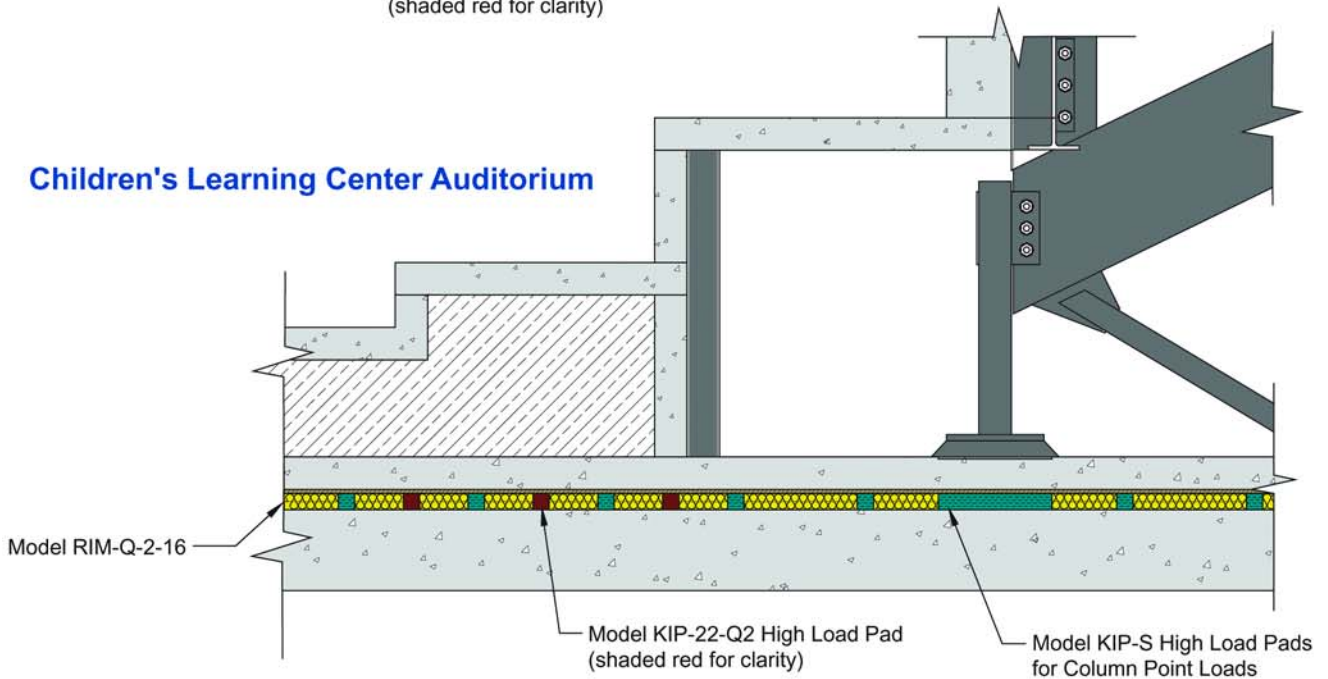

Acoustical Tests

2" Topping Slab
Precast Concrete 14" Tee

STC 54

IIC 24

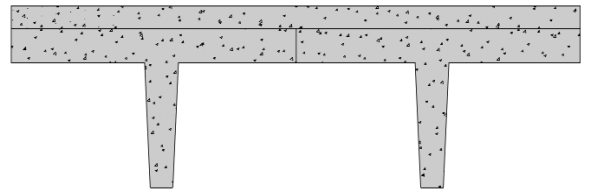

Kinetics Test Number A2-a

4" Concrete Slab
1/2" Plywood
Kinetics® RIM L-2-12
2" Topping Slab
Precast Concrete 14" Tee

STC 73

IIC 70

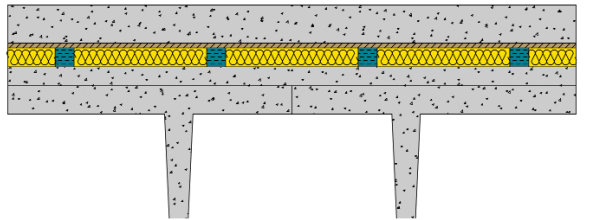

Kinetics Test Number A2-b and A3

4" Concrete Slab
5/8" Plywood
Kinetics® RIM Q-2-12
4-7/8" Concrete Slab with 17" Tee
Drop in Acoustical Ceiling

FSTC 72

FIIC 68

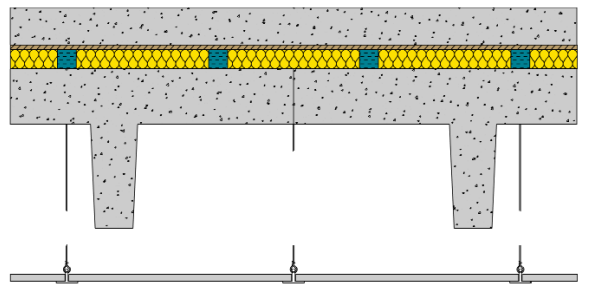

Kinetics Test Number A11

4" Concrete Slab
1/2" Plywood
Kinetics® KIP-22-Q2 Isolation Pads
6" Concrete Slab

STC 68

IIC 60

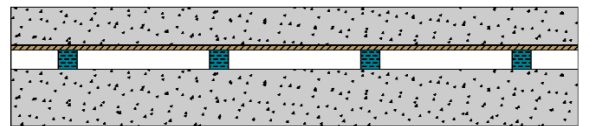

Kinetics Test Number A13-a

4" Concrete Slab
1/2" Plywood
Kinetics® RIM-Q-2-16 Isolation System
6" Concrete Slab

STC 72

IIC 62

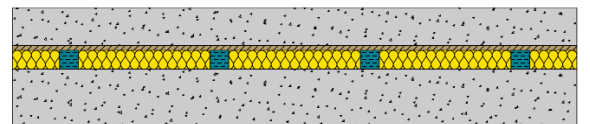

Kinetics Test Number A13-b

1" Oak Hardwood Floor
3" Subfloor

LOFT

FIIC 15



Kinetics Test Number A14-a

3/4" Oak Hardwood Floor
3/4" Sleepers
1-1/2" Gypcrete
2 Layers 1/2" OSB
1" Kinetics® RIM L-1-16
1" Oak Hardwood Floor
3" Subfloor

**LOFT
W/ 1" RIM**

FSTC 50

FIIC 45

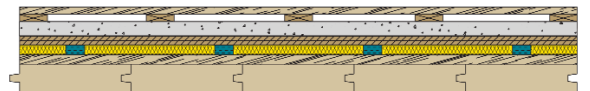

Kinetics Test Number A14-b

3/8" Plywood
2 Layers 3/4" Plywood
Kinetics® RIM I-2-16
6" Concrete Slab

STC 66

IIC 63

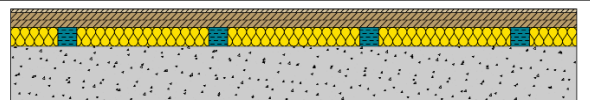

Kinetics Test Number A15-a

3/8" Plywood
3/4" Plywood
2 Layers 5/8" Drywall
3/4" Plywood
Kinetics® RIM I-2-16
6" Concrete Slab

STC 71

IIC 64

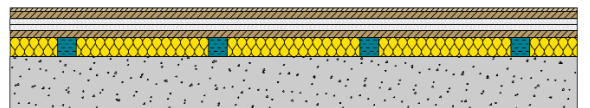

Kinetics Test Number A15-b

Noteworthy Projects

Over our 45-plus year history, thousands of Kinetics Model RIM systems have been installed successfully under mechanical equipment rooms, gymnasium floors, rooftops, aerobic and fitness centers, theater and cinema venues, recording and broadcasting studios, private residences, loading docks, gun ranges, and bowling centers around the world. Below, we've listed just a few of our noteworthy projects.

- University of Illinois Recreation Center
- Boston University Arena Mechanical Room
- 8th & I Marine Barracks Music Rooms
- Florida State University Communications Studios
- Cincinnati State Audio Studio and Control Room
- CNN Studios
- WWF Entertainment Studios
- ESPN Studios
- University of Akron Student Union Ballroom
- Naismith Basketball Hall of Fame Office and Projection Room
- Hibbing College Gun Range
- Ramsey County Law Center Gun Range
- National Underground Railroad Freedom Center Mechanical Rooms
- Soldier Field-Chicago Bears Stadium Renovation Rooftop
- Elder Shirt Lofts Condominiums
- Gene Siskel Film Center Theater
- Navy Pier USO Lounge
- Lucky Strike Lanes at Gallery Place
- First Baptist Church of West Palm Beach Gymnasium and Fellowship Hall
- LA Fitness Centers
- Georgia International Convention Center Rooftop
- AMC Easton 30 at Easton Town Center
- Muvico Centro Ybor 20 Multiplex Theater
- LSU Music and Arts Building Percussion Studios
- Peabody Institute Rehearsal Hall and Percussion Room Renovation
- Brophy College Preparatory Gymnasium
- University of the Ozarks Tutoring Rooms
- IU Professional Medical Building Mechanical Room
- Cass Technical High School Mechanical Equipment Rooms
- Brown Camp Loft Condominiums

Call us to discuss your requirements for noise control, and learn how to employ the versatile, proven Model RIM System to solve your noise problems.

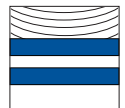

Essentials:

- Proven effectiveness over the lifetime of an installation.
- Quick installation time, especially compared to “jack-up” methods.
- Constant System natural frequency across a wide load range.
- Flexible capacities allow design for any load; from light wood floors to heavy mechanical equipment rooms.
- When used in conjunction with ceiling and wall separation products, Model RIM is an essential component of “room-within-a-room” sound isolation construction.



United States

6300 Irelan Place
P.O. Box 655
Dublin, Ohio 43017
Phone: 614-889-0480
Fax: 614-889-0540

Canada

1720 Meyerside Drive
Mississauga, Ontario
L5T 1A3
Phone: 905-670-4922
Fax: 905-670-1698

www.kineticsnoise.com
archsales@kineticsnoise.com

Kinetics Noise Control, Inc. is continually upgrading the quality of our products. We reserve the right to make changes to this and all products without notice.

Download Model RIM information including three-part specification, installation guidelines, and typical installation drawings at www.kineticsnoise.com/arch/rim.html. Call the factory at 800-959-1229 if needing additional information; ask for Architectural sales. Purchase Model RIM and accessories through your local sales representative (www.kineticsnoise.com/relocation.asp).